

**PART No. RCBS1900517**

for more information visit  
[www.hammondmfg.com](http://www.hammondmfg.com)

Data subject to change without notice

ISOMETRIC VIEW NOT TO SCALE

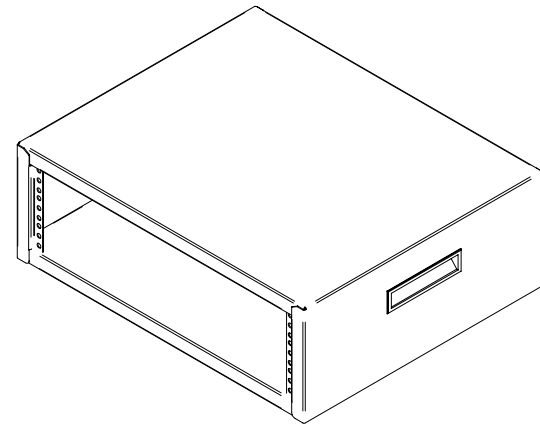

HOLE SPACING PER  
EIA-310-D UNIVERSAL

